

84.63

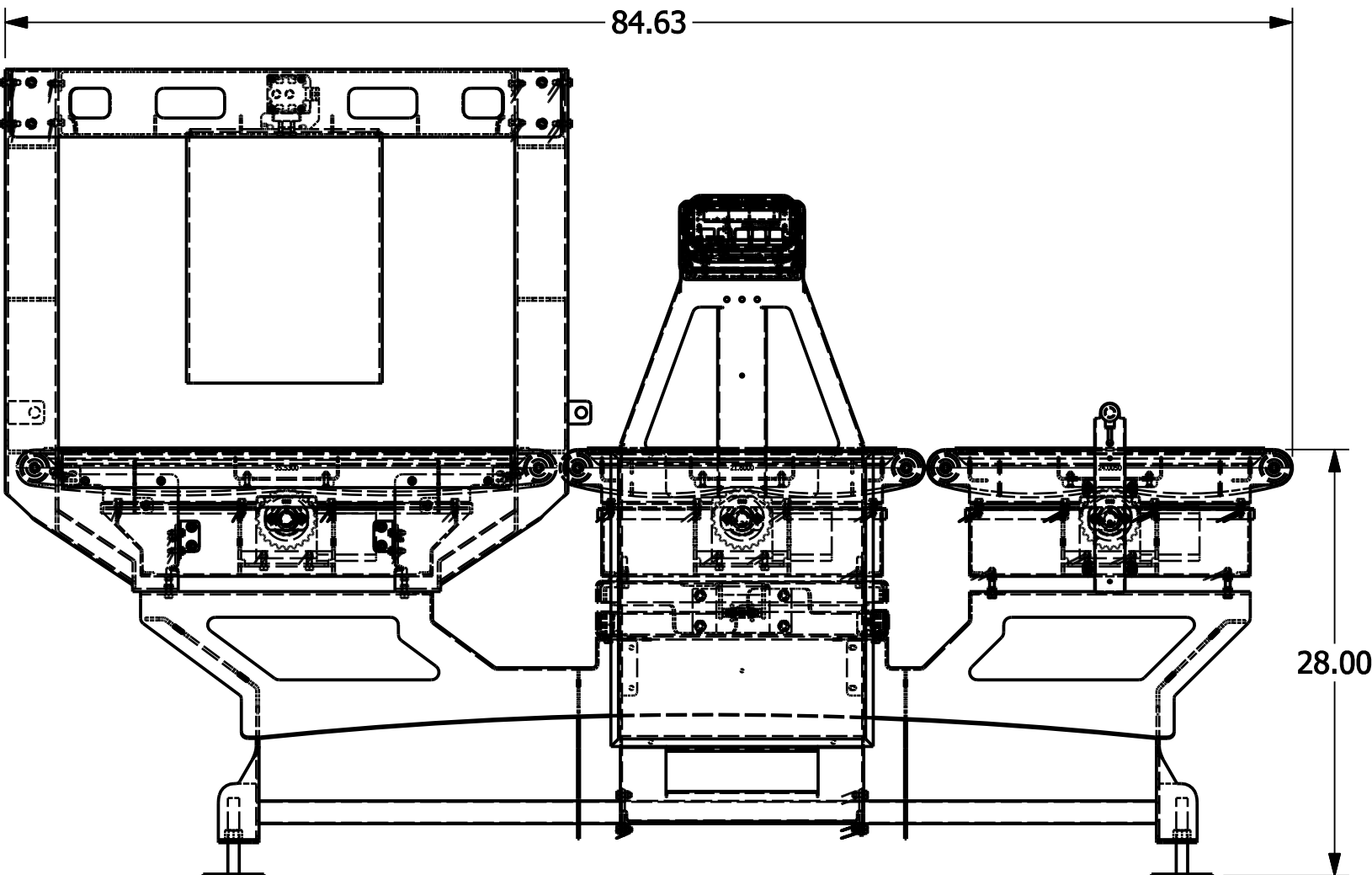

28.00

